

DIN 332-DR M16
 DIN 6885-1

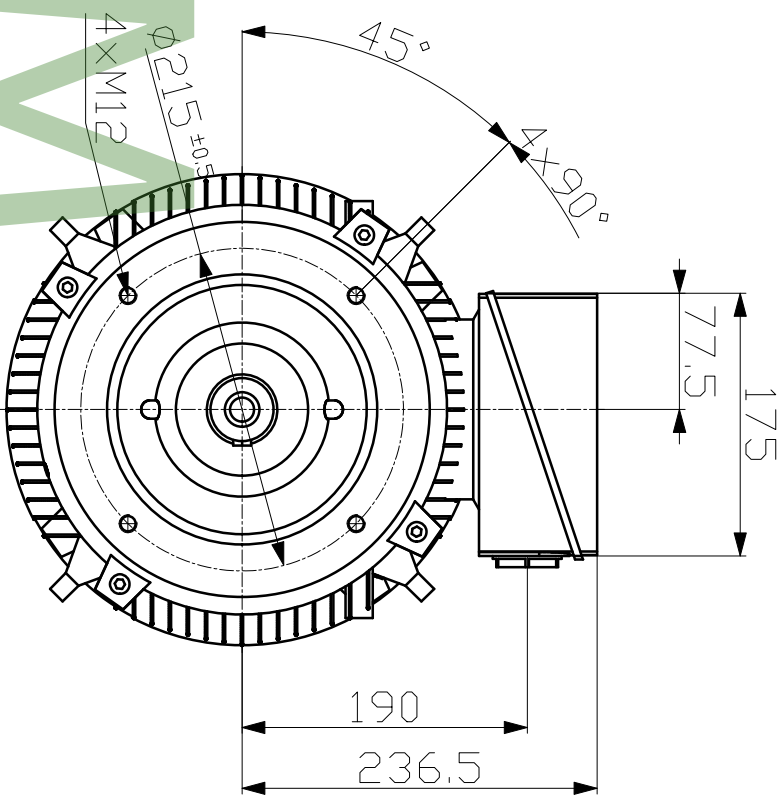

Tolerance		Surface		Material		Weight		Scale	
1LE1003-1DD32-1KA4		Author		Dimensional drawing				mm	
		Creator 18/09/2025		IPC					
		Approval Created automatically		Maßzeichnung					
		Department IN LVM							
		Change Order							
		Doc State		Released		Item No		Paper Size A3	
		Revision AA		Index RS		Doc No		1st Language en	
		Project No		Ref No				2nd Language de	
								Sheet 1 of 1	

Technische Änderungen vorbehalten!
 Technical data are subject to change!

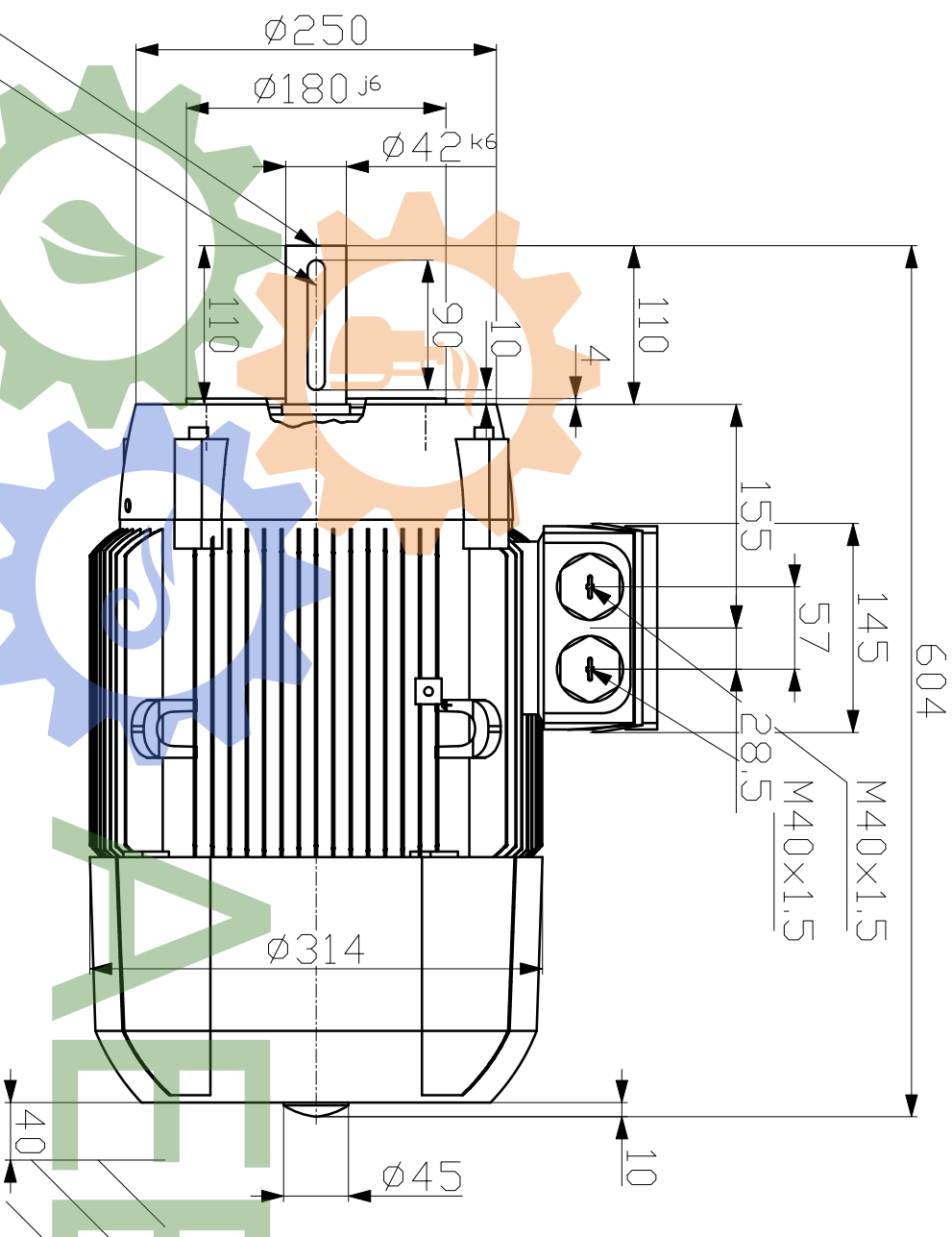
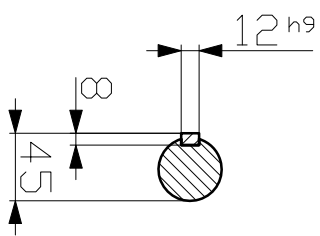